

## Basic Specifications for DC500VBT2035 180A

SOC product name DC500VBT2035 180A

### Dimensions and construction

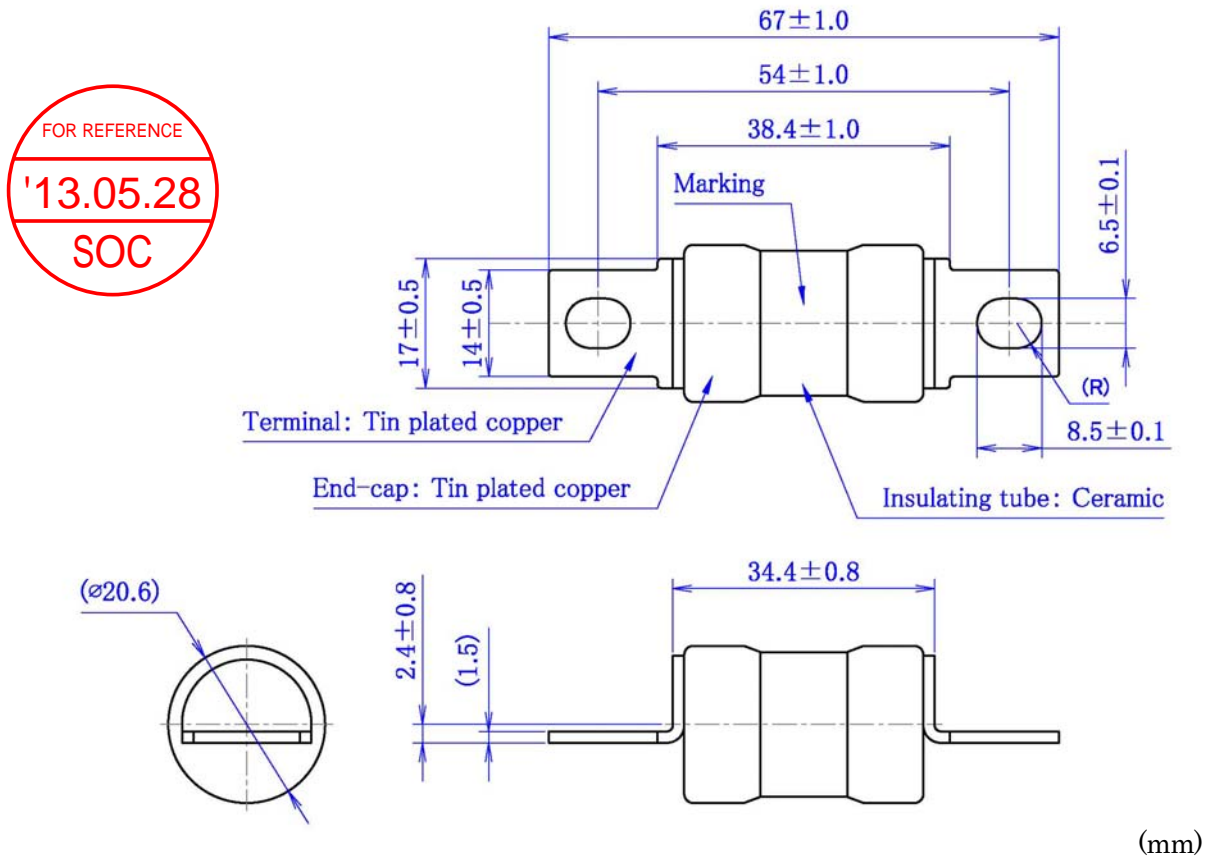

**Marking** The following shall be marked on the surface of the insulating tube:  
SOC BT2035  
DC500V 180A  
IR 2000A

### Electrical characteristics

Rated voltage	Rated current (I <sub>N</sub> )	Rated breaking current		Temperature rise	Current carrying capacity	Overload operation
DC500V	180A	2000A	Resistive circuit	Not more than 50 K at 0.5 I <sub>N</sub> on the external surface of the fuse	1.0 I <sub>N</sub> until temperature stabilization occurs.	Within 1 s at 5.0 I <sub>N</sub>

### Environment-related substances

The six hazardous substances (lead, mercury, cadmium, hexavalent chromium, polybrominated biphenyls (PBB), and polybrominated diphenyl ethers (PBDE)) specified in the EU RoHS Directive are not used intentionally in this product. This product is conforming to the EU RoHS Directive 2002/95/EC. Lead content as impurities is not more than 0.1 wt%.

## Basic Specifications for DC500VBT2035 180A

---

### Mounting conditions

Mounting bolt: M6 bolt

Tightening torque:  $6 \pm 1 \text{ N}\cdot\text{m}$



Application of excessive stress on a fuse body may damage the fuse. Make sure to secure the fuse terminal area when you tighten a bolt.

# Safety Precautions When Selecting and Using Fuses

Read and follow these precautions before selecting and using fuses.

 **WARNING :** Failure to properly select, install and use fuses can result not only in property damage but also serious injury and/or death.

■ Use fuses within their specification requirements.

 **WARNING :** Application of loads exceeding or outside the specification requirements may lead to nonoperation or nuisance operation of the fuse, disconnection of the fuse-element, and/or explosions, which may result in damage to property and/or bodily harm.

■ The electrical performance of the fuse may greatly vary depending on the various conditions of loads actually applied to it such as pulsed currents, ambient temperatures and thermal and mechanical stresses. Consider all load conditions to be applied to the fuse when selecting it.

 **WARNING :** The electrical performance of the fuse may be significantly affected by external stresses applied to it, which may cause nuisance operation of the fuse, disconnection of the fuse-element, and/or explosions, resulting in damage to property and/or bodily harm.

■ Use this fuse in DC circuits. Be aware that the breaking ability of this fuse will differ depending on whether the circuit is an AC or a DC circuit.

■ Check for appropriate operation of the fuse at the voltage of the circuit in which the fuse is to be inserted. Select a fuse whose rated voltage is higher than the voltage of the circuit. Even when the rated voltage of the fuse is higher than the voltage of the circuit, however, the fuse may not operate when the circuit voltage is too small.

■ Do not use a fuse where it can be exposed to high humidity, corrosive gas and/or flammable gas. Doing so may result in nuisance operations, disconnection of the fuse-element, or explosions.

■ Turn off all power leading to the fuse before touching it. Failure to do so may result in electric shocks and/or serious burns.

■ Before final fuse selection, always test the proposed fuse in your actual equipment to ensure that the fuse satisfies all your operational and safety requirements.

■ Use sample fuses only for evaluation. Do not reuse sample or other used fuses. Properly dispose of fuses in accordance with local laws and regulations.

## I-t Curve (For reference purposes only)

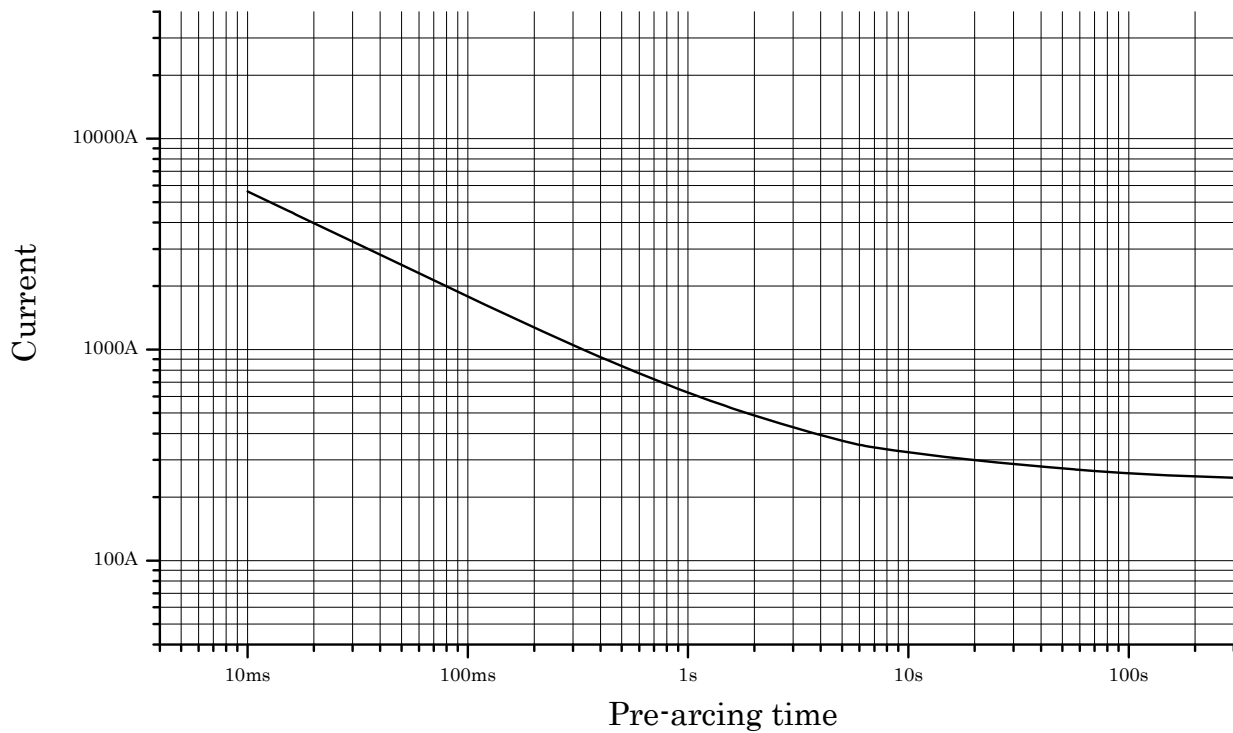
**Note:**

- This I-t curve is a plot of the average values of measurements obtained under conditions specified by SOC.
- These data are for reference purposes only and are not intended to infer any guaranteed values.
- Fuse characteristics may vary depending on the usage conditions. Always test the fuse in the circuit under the actual circuit conditions.

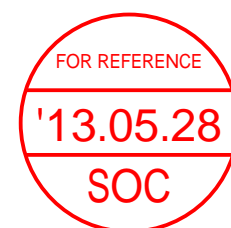

# I<sup>2</sup>t-t Curve

FOR REFERENCE ONLY

(ご参考)

このI<sup>2</sup>t-t特性図は、弊社が試験条件を特定して測定した実測値の平均値だけをプロットしてあります。参考値であり保証値ではありません。ヒューズの特性はその使用条件により変化しますので、お客様にヒューズのご使用条件下で、ヒューズがお客様のご要求を満足しているかを実際にご確認頂く必要があります。

This I<sup>2</sup>t-t curve is a plot of the average values of the measurement obtained under the conditions specified by our company.

These data are for reference only and are not intended to infer any guaranteed values.

Characteristics of the fuse may vary depending on the usage conditions. Always test the fuse in the circuit under the actual circuit conditions.

Type: DC500VBT2035 180A

Control No.: 121122

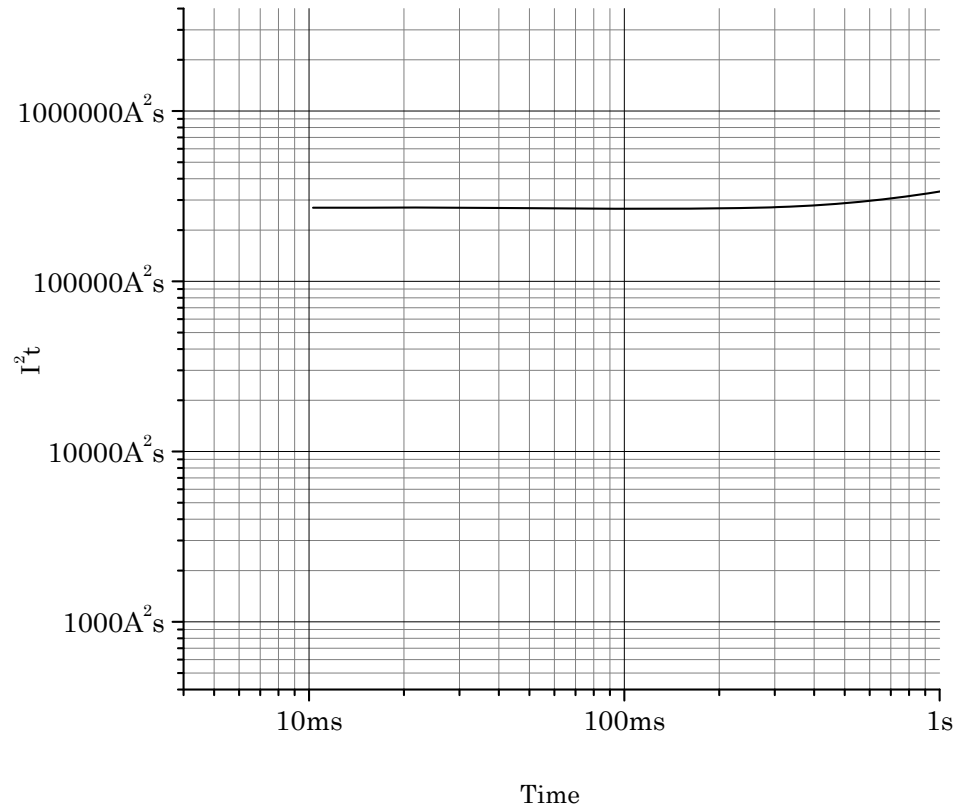

## 周囲温度の影響－定格電流値のリレーティング

### Influence of Ambient Temperature - The Re-rating of the Rated Current

この周囲温度に対する定格電流の変化を示すグラフは、周囲温度-40℃、25℃及び125℃に於いて弊社が特定した条件で測定した3点の実測値であり、お客様での実使用条件を考慮したものではありません。ヒューズの特性はその使用条件により変化しますので、お客様にヒューズのご使用条件下で、ヒューズがお客様のご要求を満足しているかを実際にご確認頂く必要があります。

This chart is a plot of the measurements obtained at the ambient temperatures of -40℃, 25℃ and 125℃ under the conditions specified by SOC; therefore, conditions of your actual application are not considered in this chart. These data are for reference purposes only and are not intended to infer any guaranteed values. Fuse characteristics may vary depending on the usage conditions. Always test the fuse in the circuit under the actual circuit conditions.

Type: DC500VBT2035 180A

Control No.: 110608

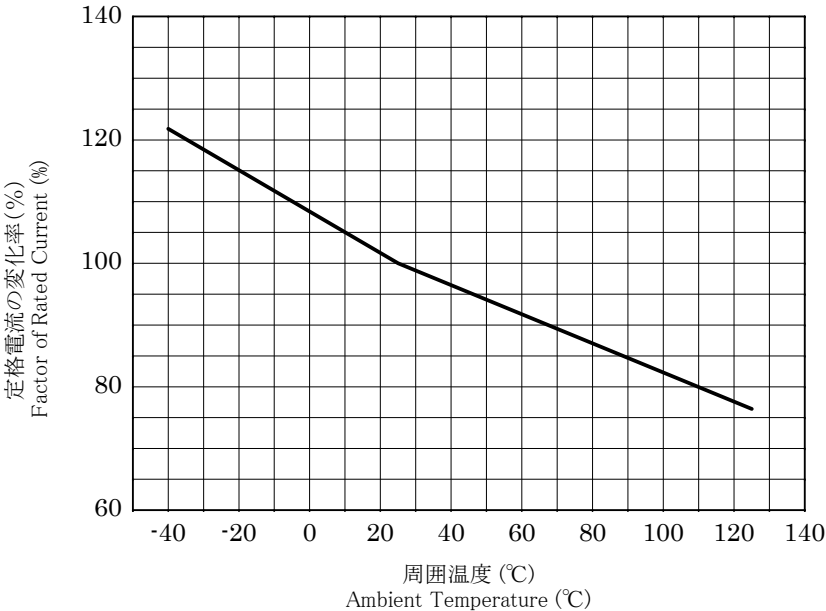

# SOC Corporation

## 《Technical specification》 (DC500VBT2035 180A)

### 1. Usage conditions

Ambient temperature: -40 °C—+125 °C

Note: Current carrying capacity of the fuse may vary depending on the ambient temperature.

Ambient humidity: 85 % RH or less

### 2. Typical cold resistance (for reference)

0.35 mΩ

